

1 General Information / Product Overview

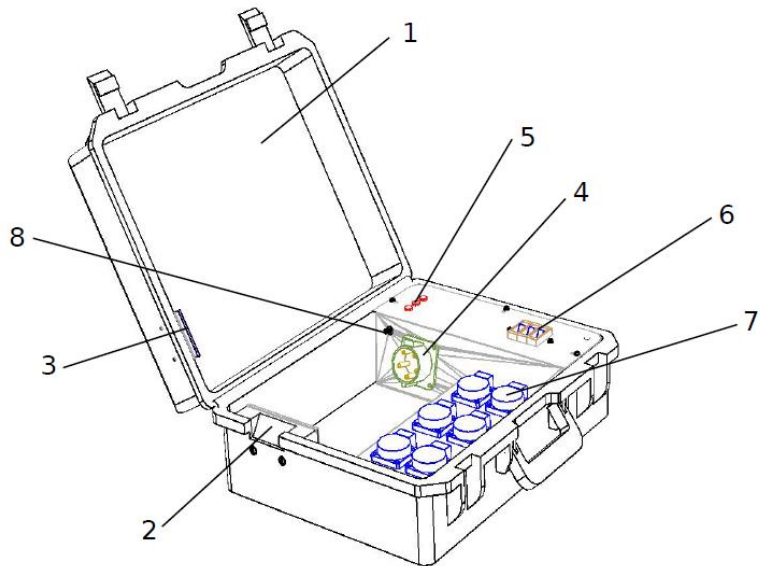











































1. Case IP 44
2. Cable entry
3. Cover cable entry
4. Input: CEE Plug MENNEKES®, 400 V/16 A, 5 Pin
5. Phase indicator lights
6. 3x RCBO C16A (Residual Circuit Breaker with Overcurrent Protection)
7. Sockets: 6 x SCHUKO® MENNEKES®, 230 V/16 A
8. Ground

2 Technical Data

Power Supply	380-400 V AC, 50 Hz
Protection Rating	IP 44
Dimensions /LxWxH/	510x410x200 mm
Weight	7 kg

3 Application Notes

	<b>Storage during operation</b>					
	     	     	     	     	     	     
						

4 Safety Information

	<b>Required Installation skills</b>
	Installation only by persons with relevant electrotechnical knowledge and experience! <b>Contact your professional electrical contractor!</b>



# Product Description

**PDS-16/s**  
Power Distribution Case RCBO



Version 1.1



**GLP German Light Products GmbH**

Industriestr. 2, 76307 Karlsbad, Germany  
Tel: +49 (0)72 48 / 927 19 - 0, Fax: -30,  
E-Mail: [info@glp.de](mailto:info@glp.de), Internet: [www.glp.de](http://www.glp.de)



[support@glp.de](mailto:support@glp.de)  
[www.glp.de](http://www.glp.de)