

RGBW

Beam opening
(m)

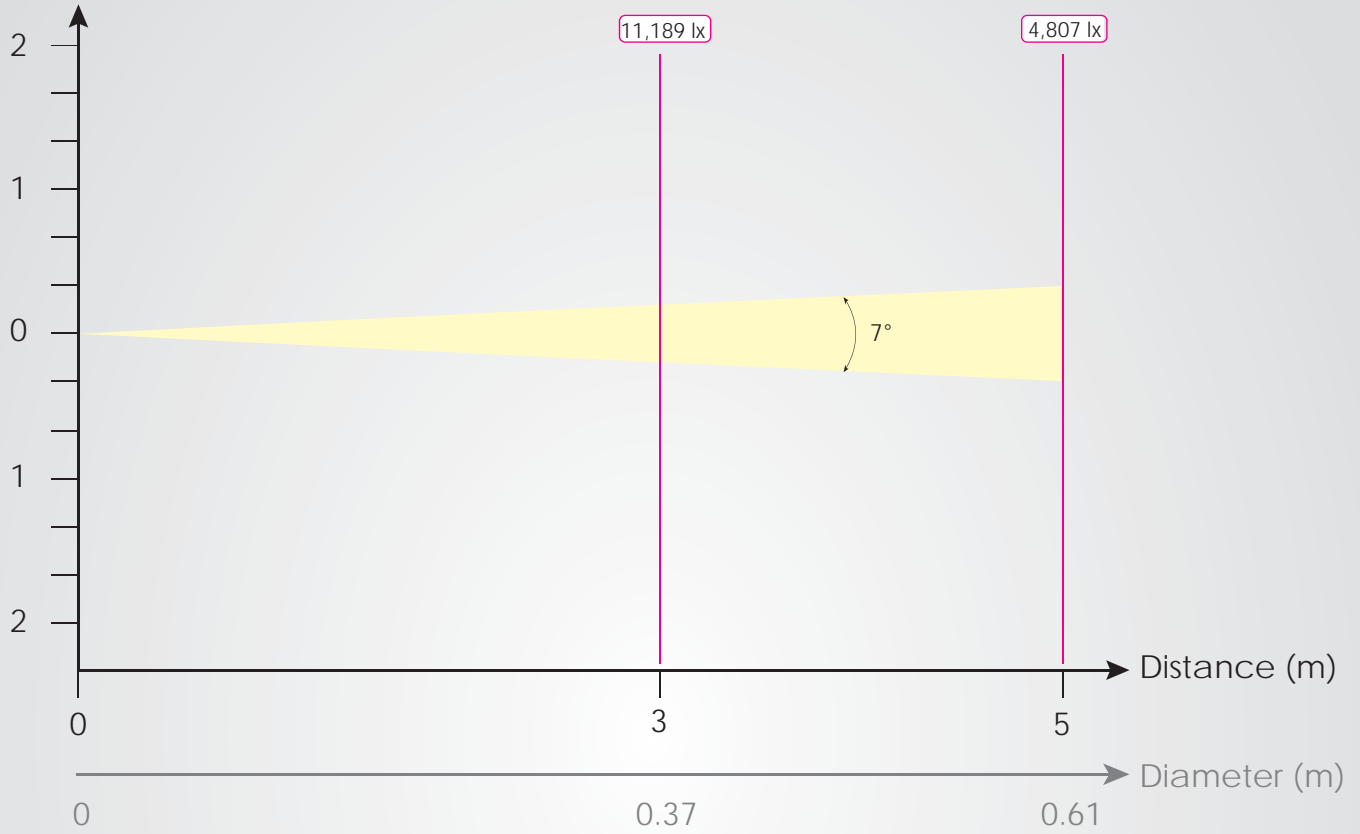

R

Beam opening
(m)

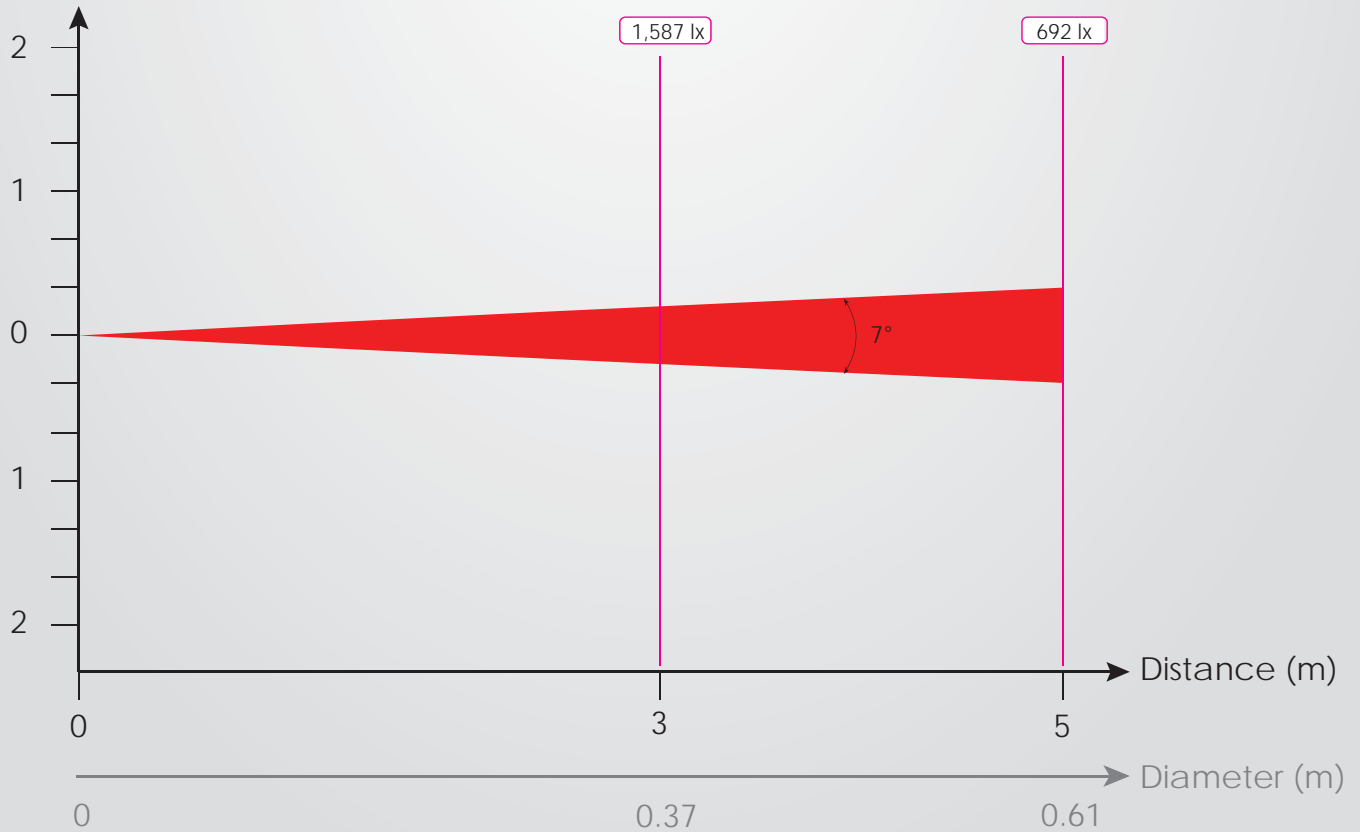

G

Beam opening
(m)

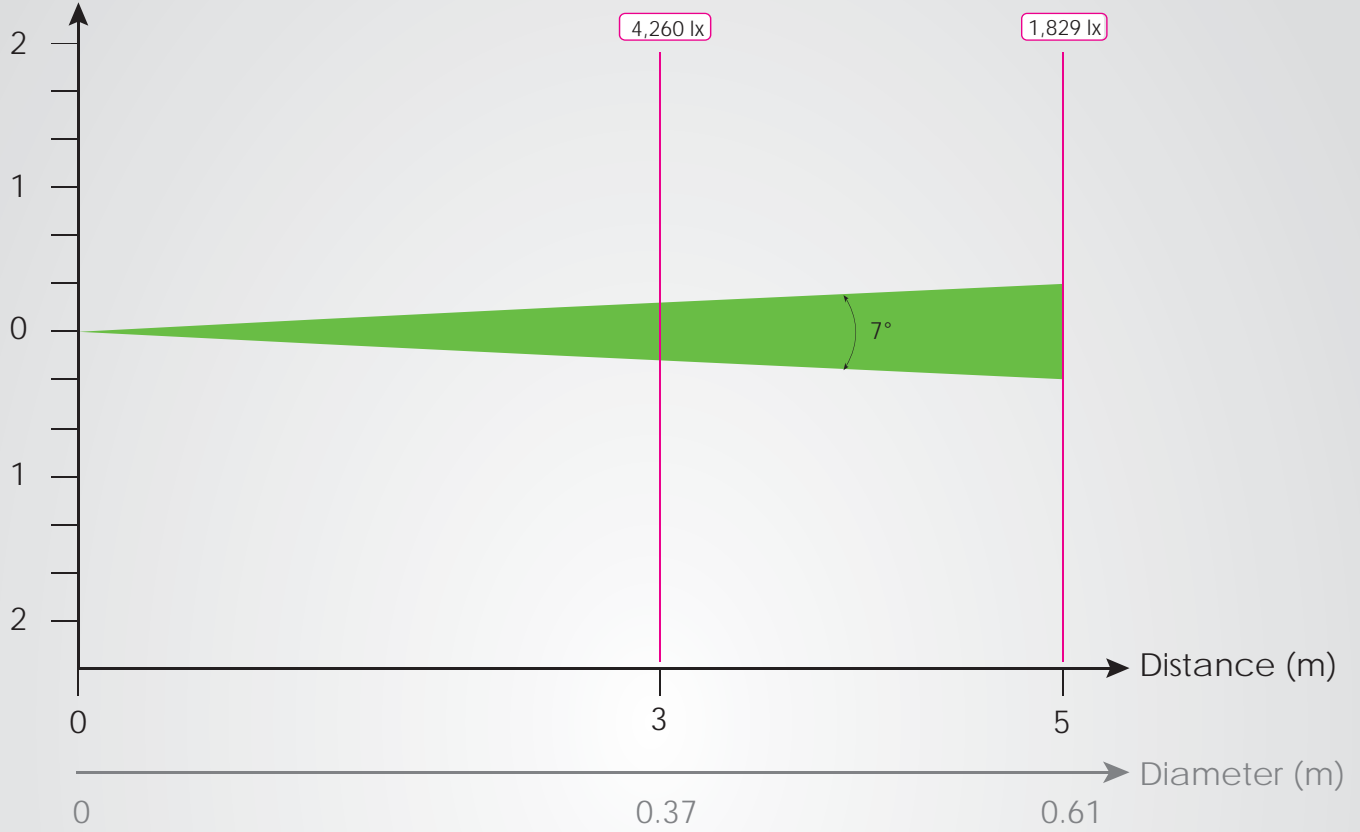

B

Beam opening
(m)

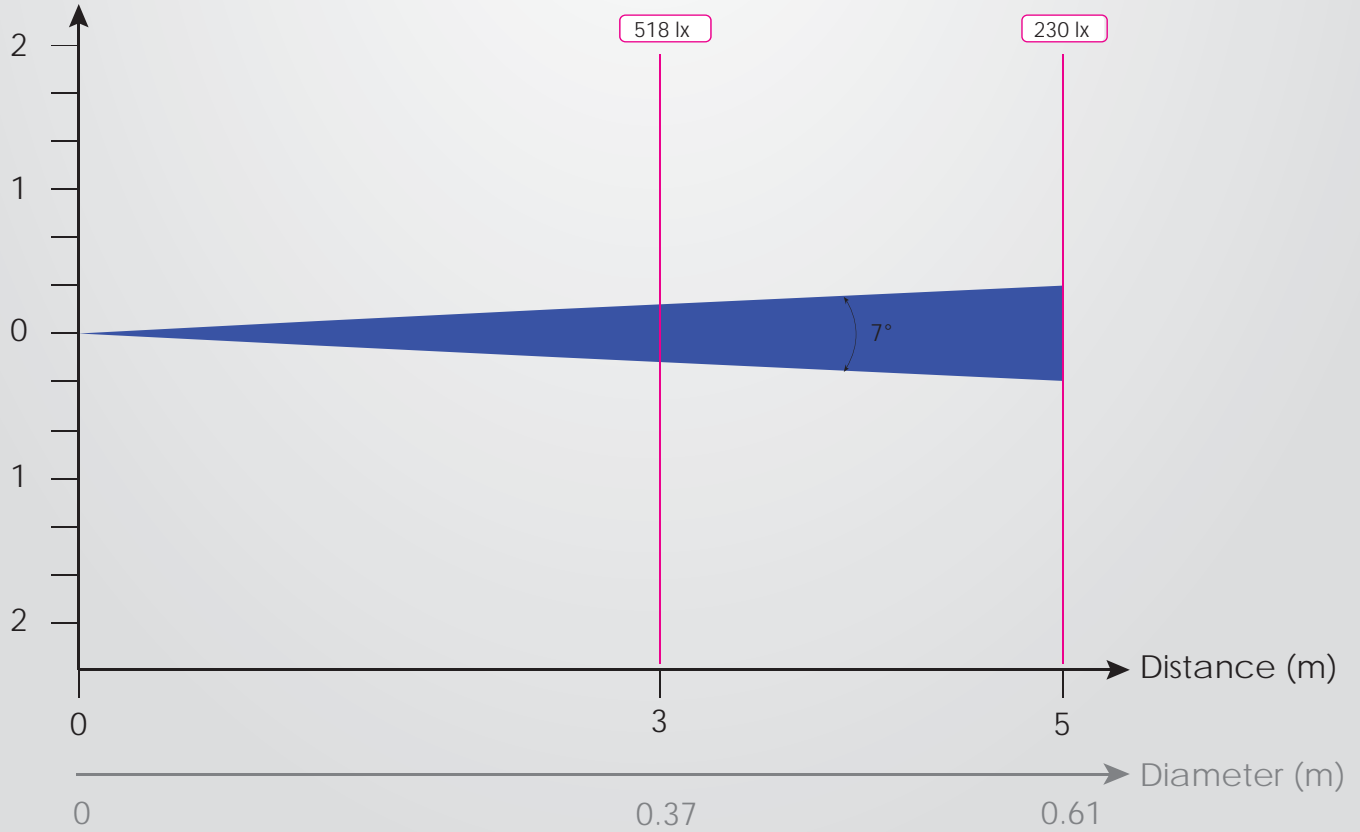

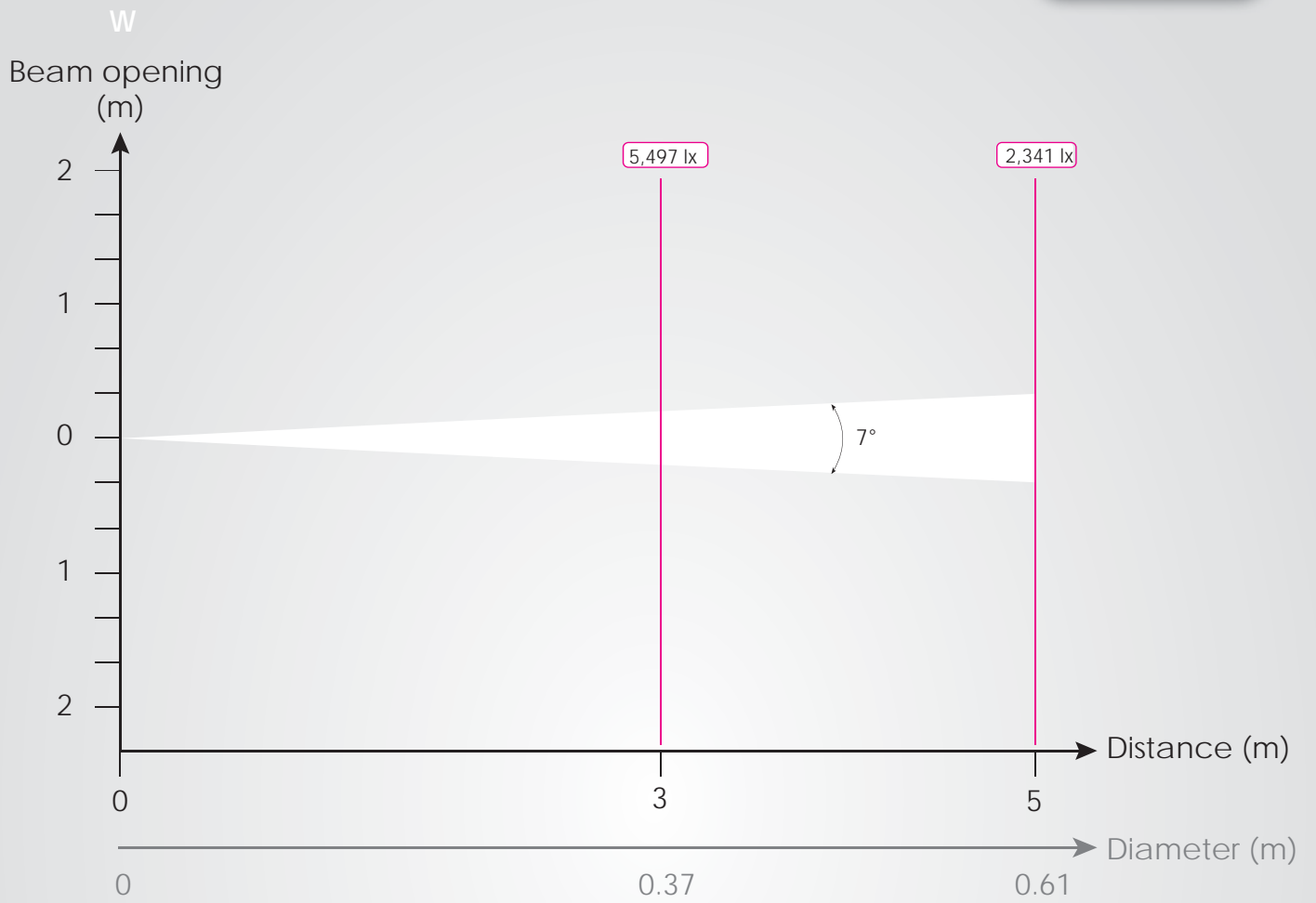

RGBW

Beam opening
(m)

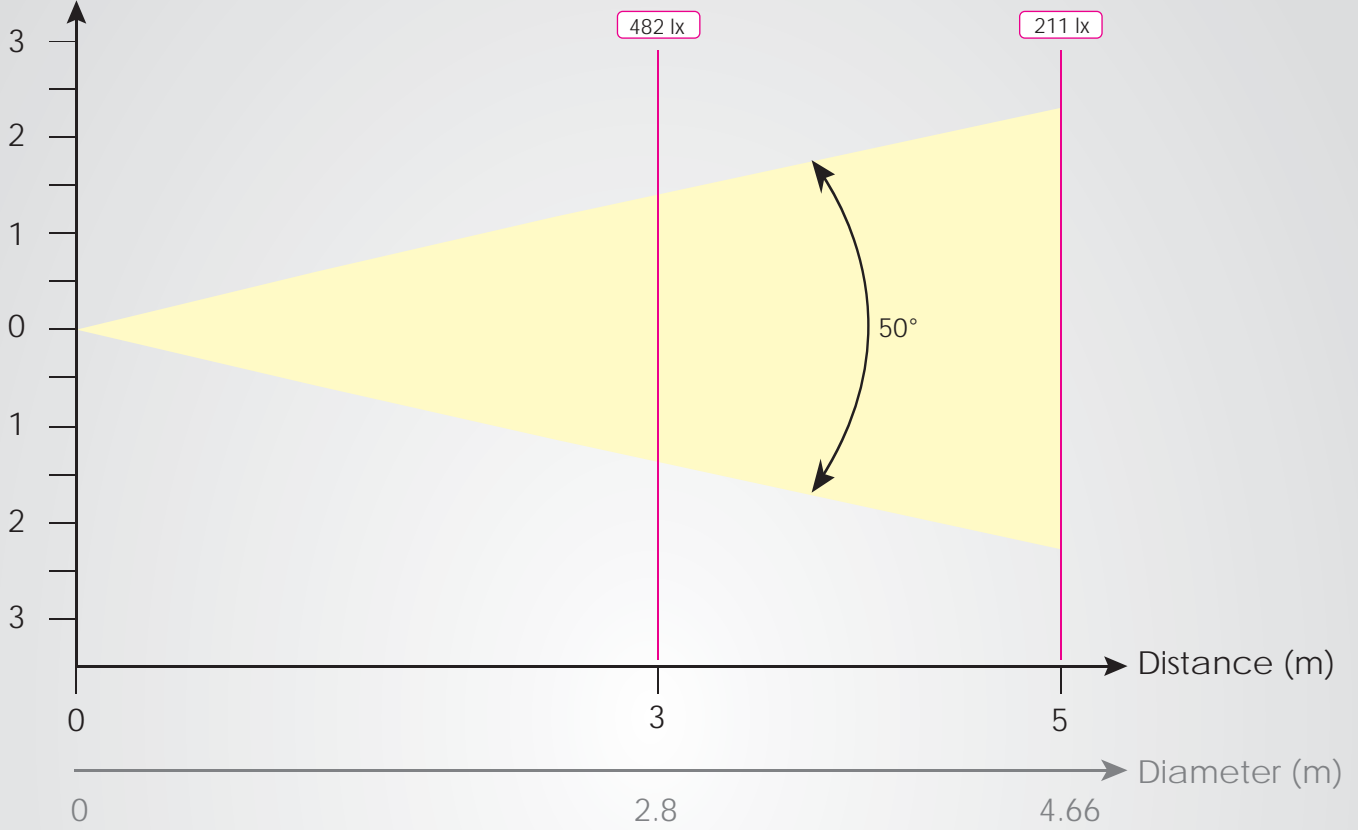

R

Beam opening
(m)

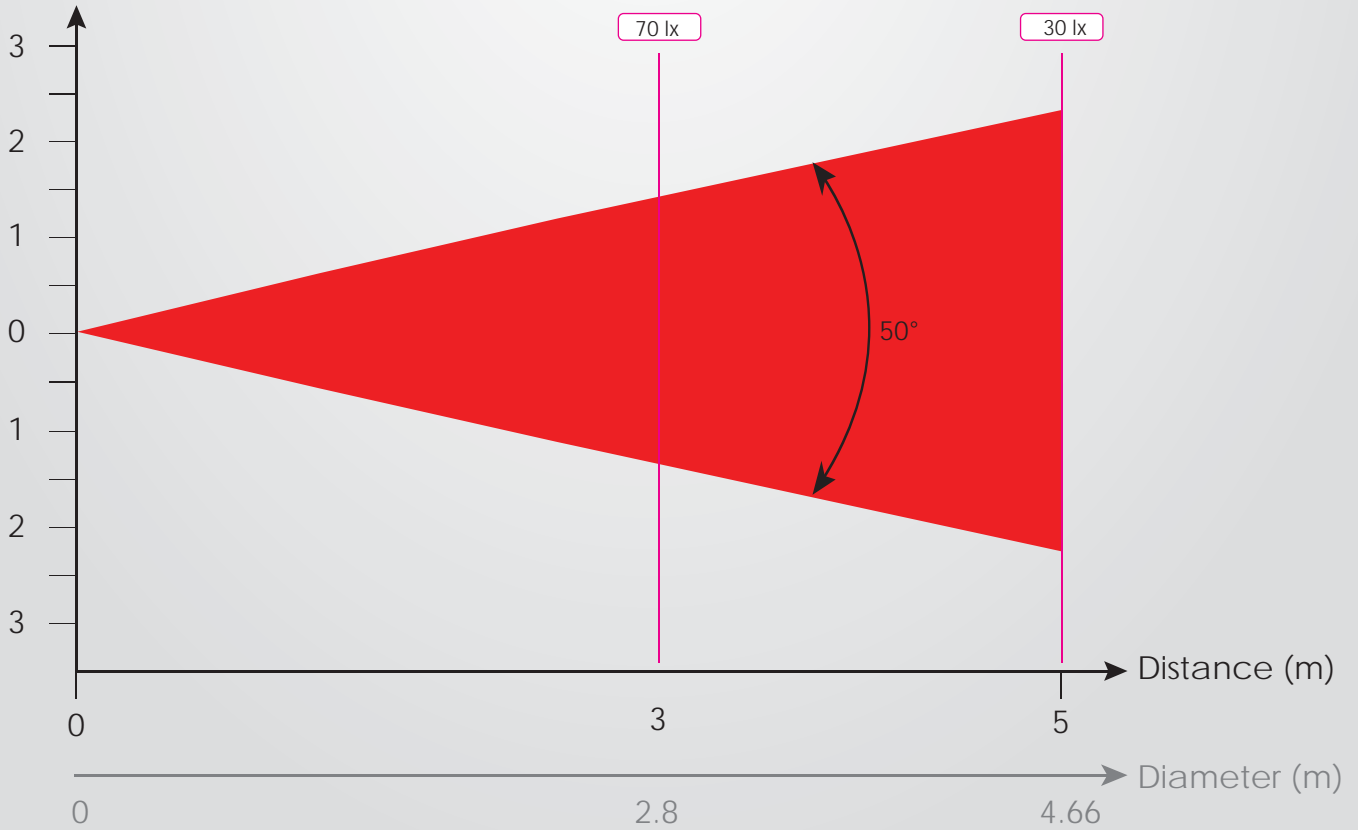

G

Beam opening
(m)

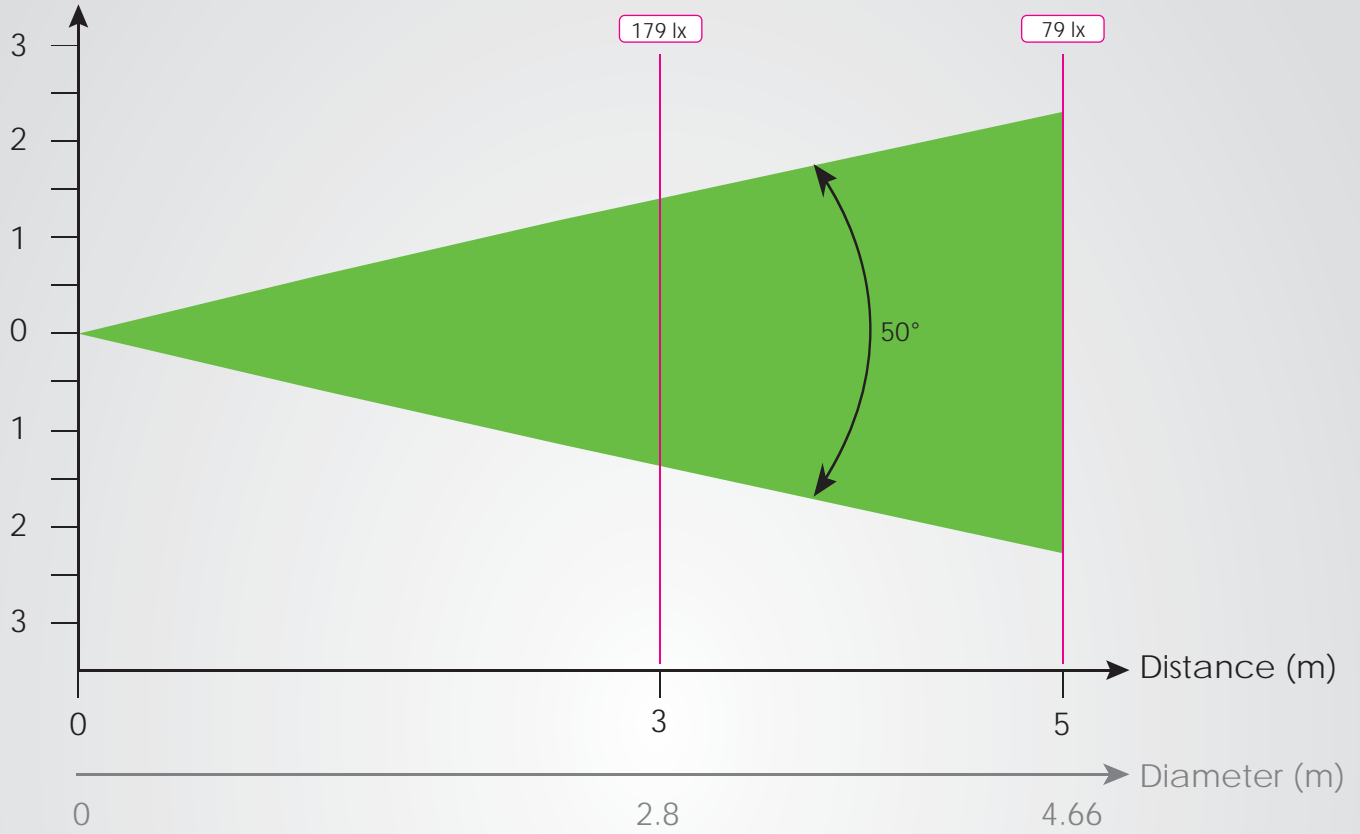

B

Beam opening
(m)

