

impression *Spot* *one*

Instruction Manual



from software version 1.61
(Instruction version 1.97)



**GERMAN LIGHT
PRODUCTS**

e-mail: service@glp.de
Internet: <http://www.glp.de>

Table of contents

1	Description of Device.....	4
1.1	Safety Instructions	5
2	Preparation and Installation	6
2.1	Mounting	6
2.1.1	<i>Mounting on the floor (upright).....</i>	<i>7</i>
2.1.1	<i>Mounting in hanging position (Head down).....</i>	<i>7</i>
2.1.2	<i>Mounting in sideways position</i>	<i>8</i>
2.2	Securing the device	8
2.3	Connections.....	9
2.3.1	<i>Power Supply.....</i>	<i>9</i>
2.3.2	<i>DMX.....</i>	<i>9</i>
3	The Menu Field	9
4	Changing Gobos and the Effect wheel.....	22
4.1	Changing Gobos and the Effect wheel	22
4.1.1	<i>General remarks for changing gobos.....</i>	<i>22</i>
4.1.2	<i>Changing rotating gobos.....</i>	<i>23</i>
4.1.3	<i>Changing the effect wheel</i>	<i>26</i>
5	Colored Error Code	28
6	Maintaining and Cleaning the Impression Spot one	28
6.1	Safety regulations	28
6.2	Maintenance Intervals (rule-of-thumb)	29
7	Technical Specifications	30
8	Index.....	31

Description of Device

1. Moving Head
2. Arm with various cooling vents
3. Tilt-lock to secure and lock the tilt movement
4. Backlight LCD graphical menu (data entry)
5. Base with various connectors and Camlock mounting system

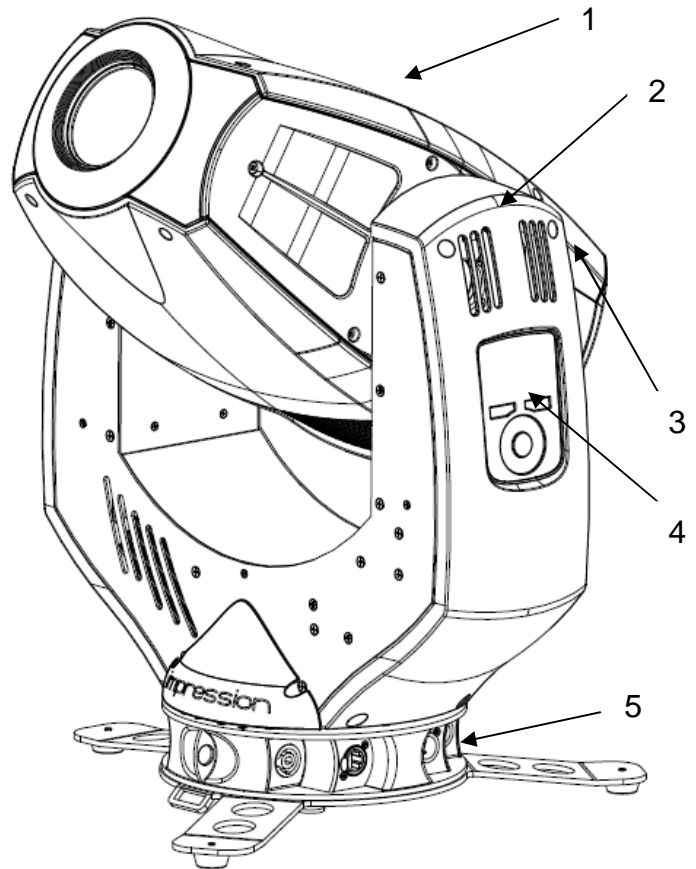

Base Side 1

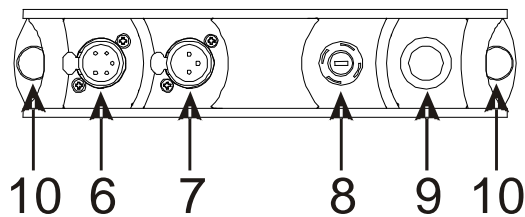

Base Side 2

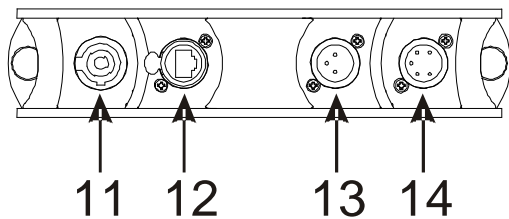

6. DMX- Output (5 Pin)
7. DMX- Output (3 Pin)
8. Micro-fuse 6.3x32mm, T8A
9. Power Switch
- 10.2x Safety wire points
11. Neutrik Powercon (Mains power input)
12. Blank panel (primed for Ethernet)
13. DMX- Input (3 Pin)
14. DMX- Input (5 Pin)

Note: Only connect one cable to the DMX Input / Output at the same time!

1.1 Safety Instructions



The **Impression Spot one** is an advanced technology product. To guarantee smooth operation, it is necessary to follow the following instructions.

The manufacturer of this device will not take responsibility of damages through any disregard of the information in this user manual. Warranty claims will also be cancelled in the event of the system casing being opened.

1. Make sure that before powering up the fixture, the fans and air inlets are clean and not blocked by anything.
2. Before powering up the fixture, ensure that the moving head part of the fixture can rotate unhindered through its full range of movement.
3. A safety distance of at least 0.5 m to any easily flammable material (e.g. decoration material) must be adhered to.
4. **Attention!** Don't touch the device during operation. Parts of the fixture can become hot and can cause injuries and / or damages.
5. Use only one DMX Input / Output at the same time.
6. **Never look directly into the beam of light or one of the LEDs.** Never use optical apertures with a distance less than 0.5 m to observe the beam of light. **LED Class 2M.** Not following these precautions can result in serious injury to your eyes and in particular, your retina.



Attention: LED Class 2M can cause injuries of your eyes even without optical instruments in front of them or within a distance of less than 0.5m and short exposure time.

Avoid direct radiation to your eyes!

7. To ensure proper operation, you must also follow the installation guide described in chapter 1 of this manual. Operating the **Impression Spot one** without suitable mounting devices can increase the risk of an accident.
8. The **Impression Spot one** features a unique small and lightweight design with no specific carrying handles. Care needs to be shown when handling the fixture to ensure that no unnecessary damage should occur. Fragile areas include the LCD display and cover on one side arm and the front bezel. Pressure in these areas could result in damages which will not be covered by the standard warranty.
9. Repair, maintenance and installation work should only be performed by qualified or GLP certified staff. You need to pay attention to the common

rules of technology that are not explicitly mentioned in this manual.

10. Use only original spare parts. Any structural modification on the system will terminate all warranty claims.
11. Please keep this instruction manual for future reference.

1 Preparation and Installation

1.1 Mounting

The **Impression Spot one** is fully operational whether it hangs or is mounted to a wall. It can also be operated while standing on the floor. Keep a safety distance of 0.5 m from any easily inflammable materials (decoration etc.).

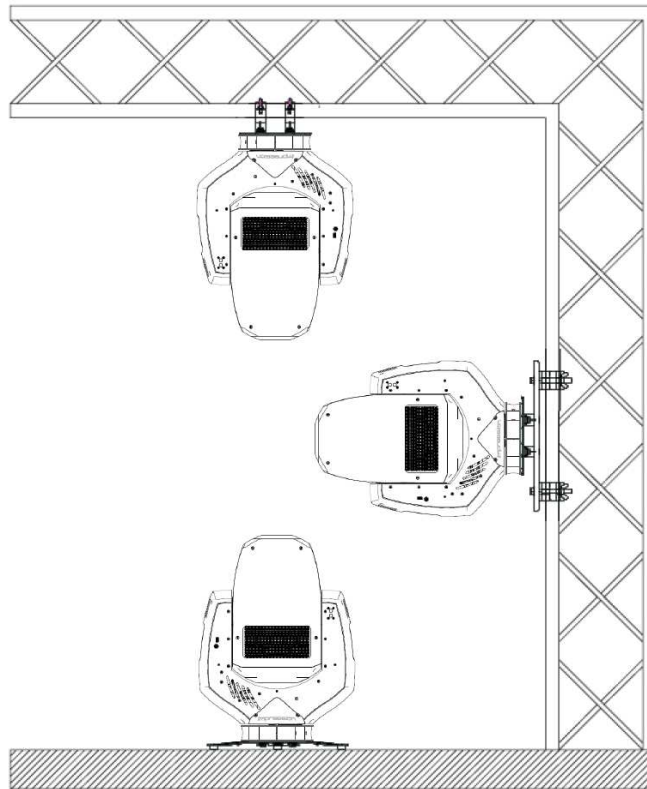

Pay attention to the regulations of: BGV C1 (former VBG 70) and DIN VDE 0711-217.

The installation shall be done by qualified personal only.

For the various mounting positions of the **Impression Spot one** (standing on the floor, sideways or hanging) different accessories kits are available. Using any required kits, along with the standard mounting connectors on the base of the fixture, will ensure a safe and firm installation.

1.1.1 Mounting on the floor (upright)

To operate the **Impression Spot one** in an upright position, please use the dedicated floor-stand which is shipped with all original fixtures. The floor stand is mounted to the base of the fixture using the two Camlock quarter turn fasteners. Line up and engage the camlock connectors from the floor stand into the base of the fixture and turn the two fasteners 90° to lock them. Do the opposite to release them again. On both sides you'll find eyelets to pull through a ratchet strap. This allows additional bracing of the floor-stand during upright operation.

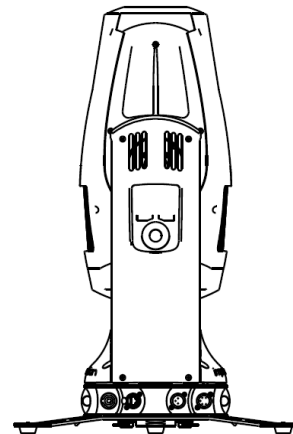
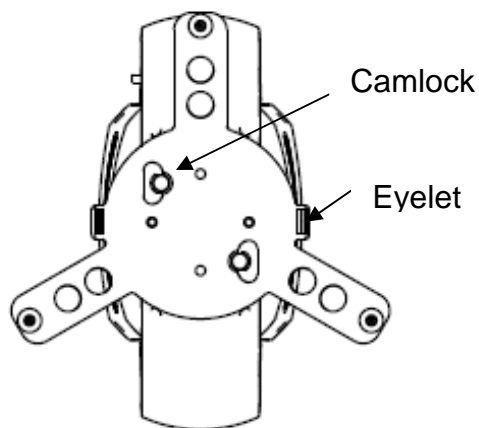
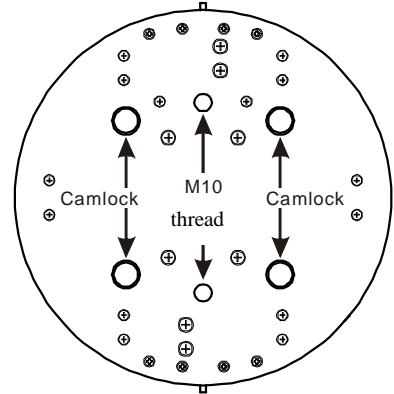

1.1.1 Mounting in hanging position (Head down)

To operate the **Impression Spot one** in a hanging position, two omega brackets can be mounted directly to the bottom of the base using the four Camlock connectors.

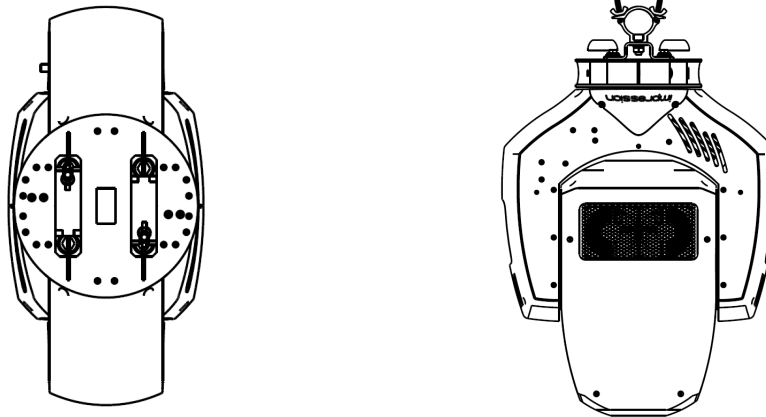

1.1.2 Mounting in sideways position

To operate the **Impression Spot one** in a sideways position, please use an additional mounting bar, available from GLP or one of their agents. This mounting bar is fixed via the four camlock quick-release connectors. Two half-couplers or clamps are then used to hang fixture. This technique is necessary to cope with the additional torque in this mounting position. Never use the "Mounting in hanging position" technique described above to secure the fixture in a sideways position, as the fixtures base can become damaged, and a secure installation cannot be assured.

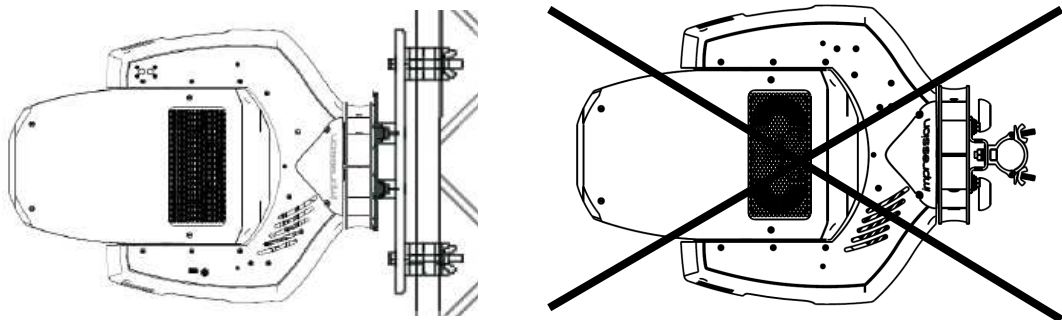

1.2 Securing the device

Regardless of the mounting method of the **Impression Spot one** you'll have to use a secondary safety wire. This safety wire can be attached to the fixture by threading it through one of the two holes provided on the base of the fixture. Ensure that the safety wire is securely fastened through the fixture and the fixtures mounting support. Install a safety wire that can hold at least 10 times the weight of the fixture.

1.3 Connections

1.3.1 Power Supply

Autosensing ~100-240 Volt AC, 50-60 Hz, earth contact type plug via Powercon

Connected load 450 VA (W) <=> T8A (micro-fuse 6.3x32mm)

Disconnect from the mains supply before changing the fuse and use only the above described micro-fuse type.

1.3.2 DMX

USITT DMX-512 Standard input/output via 3 pin and 5 pin connectors.

3 pole: Pin 1 = [Ground] / Pin 2 = [-] / Pin 3 = [+]

5 pole: Pin 1 = [Ground] / Pin 2 = [-] / Pin 3 = [+] / Pin 4/5 n.c.

Ethernet (Artnet II compatible, ACN ready)

Neutrik RJ-45 plug (for Neutrik EtherCon connector with body)

2 The Menu Field

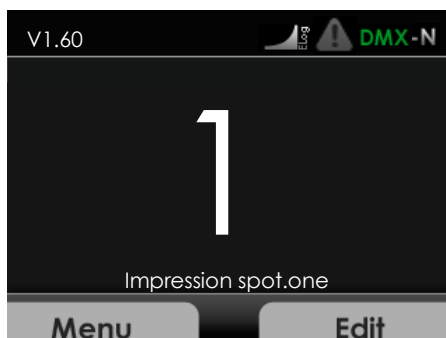

You'll find the control board on the side of the arm. It allows you to make all necessary adjustments of the **IMPRESSION Spot One**. With the **Menu**-key you get into the main menu. Afterwards you can navigate through the menu with the **Touchwheel**. Push the **Enter**-key to get to the next menu level or to confirm your settings. Select **ON/ OFF** function settings with the **Touchwheel**. Confirm and save with the **Enter**-key. Push the **Back**-key to cancel the entry and go back to the main menu.

← Back - Enter →

Layer 1	Layer 2	Layer 3	Layer 4	Notes
DMX Start Address				Set the DMX start address
Personality	Pan/Tilt			Pan/Tilt settings
		Pan invert		Selects Inverse Pan, on or off
		Tilt invert		Selects Inverse Tilt, on or off
		Feedback		Automatic position feedback selection for pan/tilt movement
	Color	Dimmer Curve		Set the Dimmer Curve
DMX		Address		Set the DMX start address
		Mode		Allows selection of the desired DMX Mode
			Compressed	Fixture works in "Compressed" mode → see also section 4
			Normal	Fixture works in "Normal" mode → see also section 4
			High-Resolution	Fixture works in "High Resolution" mode → see also section 4
		Hold Values		Defines whether the last DMX signal is stored, or the lamp is switched OFF in case of signal interruption
		Manual		Manual control of all system functions
			Pan	Manual control
			Tilt	Manual control
			Colorwheel	Manual control
			Red	Manual control
			Green	Manual control
			Blue	Manual control
			Shutter	Manual control
			Dimmer	Manual control
			Color temp.	Manual control
			Special	Manual control
			Movement	Manual control
			Movement Speed	Manual control
			Zoom	Manual control
			Focus	Manual control
			Gobo1	Manual control
		Gobo 1 rot.	Manual control	
		Gobo 2	Manual control	
		Gobo 2 rot.	Manual control	

		Effectwheel	Manual control
		Effectwheel rot.	Manual control
		Prism	Manual control
		Iris	Manual control
Artnet			Artnet adjustment
	Priority		Set the priority of Artnet and DMX input (Artnet, DMX or Merge)
	DMX/RDM out		Set the output of Artnet oder DMX
	Universe		Set the Universe
	IP Mode		Set the Artnet Mode (10.x.x.x oder 2.x.x.x)
	Custom IP		Set the manual IP address
	Custom Subnet		Manual set of the Subnet address
	Custom Gateway		Manual set of the Gateway address
Display			Adjustments for the Display
	Blackout		Sets the display On or Off
	Auto-Rot		Display will rotate automatically
	Display Inv		Display will rotate manual
	Brightness		Display backlight
	Set Default		Resetting all functions to original values
Status	Version		Shows the current software version
	Reset Hardware		Hardware reset adjust
	All		Reset all boards
	Head		Reset only headboard
	GI		Reset only Gobo & Iris
	FZP		Reset only Focus, Zoom, Prism
	Pan		Reset only Pan
	Tilt		Reset only Tilt
	Temperatures		Display all temperatures
	LED Info		Display the values for the LED's
	Red		Current value for red
	Green		Current value for green
	Blue		Current value for blue
	Error Status		Shows the error status
	Timer		Shows the life time
	DMX Input		Shows the current DMX signal per DMX channel

		Pan	Instantaneous value for pan
		Tilt	Instantaneous value for tilt
		Colorwheel	Instantaneous value for color
		Red	Instantaneous value for red
		Green	Instantaneous value for green
		Blue	Instantaneous value for blue
		Shutter	Instantaneous value for shutter
		Dimmer	Instantaneous value for dimmer
		Colortemp.	Instantaneous value for color temp.
		Special	Instantaneous value for special
		Movement	Instantaneous value for movement
		Movement Speed	Instantaneous value for movement speed
		Zoom	Instantaneous value for zoom
		Focus	Instantaneous value for focus
		Gobo1	Instantaneous value for gobo1
		Gobo 1 rot.	Instantaneous value for gobo 1 rot.
		Gobo 2	Instantaneous value for gobo 2
		Gobo 2 rot.	Instantaneous value for gobo 2 rot.
		Effectwheel	Instantaneous value for effect wheel
		Effectwheel rot.	Instantaneous value for effect wheel rot.
		Prisma	Instantaneous value for prism
		Iris	Instantaneous value for iris
	DMX Quality		Shows the DMX Quality
Service	Adjust		Adjustments for all functions. Use code to enter calibration. (only for authorized persons)
		Pan	Adjust for pan
		Tilt	Adjust for tilt
		Gobo1	Adjust for gobo 1
		Gobo 1 rot.	Adjust for gobo 1 rotation
		Gobo 2	Adjust for gobo 2
		Gobo 2 rot.	Adjust for gobo 2 rotation
		Effectwheel	Adjust for effect wheel
		Effectwheel rot.	Adjust for effect wheel rotation
		Prisma	Adjust for prism
		Prisma End Pos.	Adjust for prism end position
		Prisma Index	Adjust for prism index
		Iris	Adjust for iris

	Zoom	Adjust for zoom
	Focus	Adjust for focus
	Adjust Default set	Set all adjustments to default
	Factory Adjust	Factory internal adjustments
Testmode		Test mode
Error Log		Shows all errors in lifetime

DMX Channels

Normal-Mode 24 DMX Channels

Channel	Function	Time and Value	DMX	HEX	%	
1) PAN- coarse	0 .. 660°		0..255	00..FF	0..100	
2) PAN-fine	High- Pos ... High- Pos + 2,6°(16 Bit)		0..255	00..FF	0..100	
3) Tilt- coarse	0 .. 280°		0..255	00..FF	0..100	
4) Tilt-fine	High- Pos ... High- Pos + 1,2°(16 Bit)		0..255	00..FF	0..100	
5) Color (fixed)	Colors adjustable via RGB		0..7	00..07	0..2,5	
	Color 01 - Red		8..15	08..0F	3..5,5	
	Color 02 - Amber		16..23	10..17	6..8,5	
	Color 03 – Yellow warm		24..31	18..1F	9..12,5	
	Color 04 - Yellow		32..39	20..27	13..15,5	
	Color 05 – Green		40..47	28..2F	16..18,5	
	Color 06 – Turquoise		48..55	30..37	19..21,5	
	Color 07 – Cyan		56..63	38..3F	22..24,5	
	Color 08 - Blue		64..71	40..47	25..27,5	
	Color 09 - Lavender		72..79	48..4F	28..30,5	
	Color 10 - Malve		80..87	50..57	31..34,5	
	Color 11 – Magenta		88..95	58..5F	35..37,5	
	Color 12 - Pink		96..103	60..67	38..40,5	
	White - CTO	Color temp. 3200K		104..111	68..6F	41..43,5
	White	Color temp. 5600K		112..119	70..77	44..46,5
White – CTB	Color temp. 7200K		120..127	78..7F	47..49,5	
Rainbow Effect Stop	Stop		128	80	50	
Rainbow Effect	slow – fast Color 01 -> Color 12		129..255	81..FF	51..100	
6) Red	Color mixing system - Red	0 - 100%	0..255	00..FF	0..100	
7) Green	Color mixing system - Green	0 - 100%	0..255	00..FF	0..100	
8) Blue	Color mixing system - Blue	0 - 100%	0..255	00..FF	0..100	
9) Shutter	Shutter closed		0..15	00..0F	0..5,5	
	Shutter pulse random	slow – fast	16..47	10..2F	6..18,5	
	Shutter ramp up	slow – fast	48..79	30..4F	19..31	
	Shutter ramp down	slow – fast	80..111	50..6F	32..43	
	Shutter ramp up/down	slow – fast	112..143	70..8F	44..56	
	Random strobe	slow – fast	144..159	90..9F	57..62	

	Strobe effect pause	5s ...0,1s	160..199	A0..C7	63..77
	Strobe effect slow - fast	1 Hz .. 25 Hz	200..241	C8..F1	78..95
	Shutter open		242..255	F2..FF	96..100
10) Dimmer	Dimmer	0% - 100%	0..255	0..FF	0..100
11) Color temp.	No color temperature correction		0..7	0..07	0..2,5
	Continuous color temperature correction between 7200k - 3200k	Applicable for ALL colors ⁵⁾	8..255	08..FF	3..100
12) Gobo Shake & Special	Gobo Shake for Gobowheel 1+2 off		0 .. 15	00..0F	0..5,5
	Gobo Shake Gobowheel 1	Speed 1 Size 1..8	16..23	10..17	6..9
		Speed 2 Size 1..8	24..31	18..1F	9,5..12
		Speed 3 Size 1..8	32..39	20..27	12,5..15
		Speed 4 Size 1..8	40..47	28..2F	15,5..18
		Speed 5 Size 1..8	48..55	30..37	18,5..21,5
		Speed 6 Size 1..8	56..63	38..3F	22..24,5
		Speed 7 Size 1..8	64..71	40..47	25..27,5
		Speed 8 Size 1..8	72..79	48..4F	28..30,5
	Gobo Shake Gobowheel 2	Speed / Size see Gobo Shake Gobowheel 1	80..143	50..90	31..56
	Gobo Shake Gobowheel 1+2	Speed / Size see Gobo Shake Gobowheel 2	144..207	91..CF	56,5..81
Reset 1	Only Head	250..253	FA..FC	98..99	
Reset 2	All Funktionen	254..255	FD..FF	100	
13) Movement	No movement		0	0	0
	Movement	Size	Phase		
	PAN	1	0°		01..01
		1	90°		02..03
		1	180°		04..05
		1	270°		06..07
	PAN	2	0°		08..09
		2	90°		10..11
		2	180°		12..13
		2	270°		14..15
	PAN	3	0°		16..17
		3	90°		18..19
		3	180°		20..21
		3	270°		22..23
	PAN	4	0°		24..25
		4	90°		26..27
		4	180°		28..29
		4	270°		30..31
	TILT	size / phase see also PAN	32..63	20..3F	13..25
	PAN / TILT	size / phase see also PAN	64..95	40..5F	26..37
	PAN / TILT (inverse)	size / phase see also PAN	96..127	60..7F	38..50
	Circle	size / phase see also PAN	128..159	80..9F	51..62
	Circle (inverse)	size / phase see also PAN	160..191	A0..BF	63..75

	Lying eight	size / phase see also PAN	192..223	C0..DF	76..87
	Random movement	size see also PAN	224..255	E0..FF	88..100
14) Speed Pan/Tilt	Pan/Tilt relative movement		0..1	00..01	0..0,5
	Pan/Tilt slow – fast Use this channel 14) also for the speed of the movements (channel 13).	Pan Min. 660° Pan Max. 660° Tilt Min. 280° Tilt Max. 280°	2..255	02..FF	1..100
15) Zoom	Stepless adjustable Zoom	10°– 32°	0 .. 255	0..F F	0..100
16) Focus	Stepless adjustable Focus	infinity – near	0 .. 255	0..FF	0..100
17) Gobo1 (indexed)	Gobo 1 (open,)		0...15	00..0F	0..5,9
	Gobo 2		16..31	10..1F	6..11,9
	Gobo 3		32..47	20.. 2F	12..17,9
	Gobo 4		48..63	30.. 3F	19.. 24,5
	Gobo 5		64..79	40..4F	25..30,5
	Gobo 6		80..95	50..5F	31..37,5
	Gobo		96..111	60..6F	38..43,5
	Gobo 8		112..126	70..82	44..48
	Gobo rotation STOP		127	7F	49
	Gobo rotation, slow-fast, CW		128..192	80..C0	50..76
	Gobo rotation, fast-slow, CCW		193..255	C1..FF	77..100
18) Gobo 1 Posi./Rot	Gobo position 0 ... 540°		0..127	00..7F	0..49
	Gobo rotation STOP		128..129	80..81	50
	Gobo rotation, slow-fast, CW		130..192	82..C0	51..75
	Gobo rotation, fast-slow, CCW		193..253	C1..FD	76..99
	Gobo rotation STOP		254..255	FD..FF	99..100
19) Gobo2 (indexed)	Gobo 1 (open)		0...15	00..0F	0..5,9
	Gobo 2		16..31	10..1F	6..11,9
	Gobo 3		32..47	20.. 2F	12..17,9
	Gobo 4		48..63	30.. 3F	19.. 24,5
	Gobo 5		64..79	40..4F	25..30,5
	Gobo 6		80..95	50..5F	31..37,5
	Gobo 7		96..111	60..6F	38..43,5
	Gobo 8		112..126	70..82	44..48
	Gobo rotation STOP		127	7F	49
	Gobo rotation, slow-fast, CW		128..192	80..C0	50..76
	Gobo rotation, fast-slow, CCW		193..255	C1..FF	77..100
20) Gobo 2 Posi./Rot	Gobo position 0 ... 540°		0..127	00..7F	0..49
	Gobo rotation STOP		128..129	80..81	50
	Gobo rotation, slow-fast, CW		130..192	82..C0	51..75
	Gobo rotation, fast-slow, CCW		193..253	C1..FD	76..99
	Gobo rotation STOP		254..255	FD..FF	99..100

21) Effect wheel swing	Stepless swing of the "Motion Wheel"	0 - 100%	0..255	00..FF	0..100
22) Effect wheel Posi./Rot	Rotating stop		0..1	00..01	00..1
	Rotating slow - fast CW		1..128	01..80	1..50
	Rotating fast - slow CCW		129..254	81..FD	51..99
	Rotating stop		254..255	FD..FF	99..100
23) Prism	Prism swing out		0..5	00..05	0..2
	Prism position 0 ... 540°		6..127	06..7F	0..50
	Prism rotation stop		128..129	80..81	50,1
	Prism rotation, slow-fast, CW		130..192	82..C0	51..75
	Prism rotation, fast-slow, CCW		193..253	C1..FD	76..99
	Prism rotation stop		254..255	FD..FF	99..100
24) Iris	Iris open – closed		0..131	00..83	00..52

Compress-Mode 20 DMX Channels

Channel	Function	Time and Value	DMX	HEX	%	
1) PAN- coarse	0 .. 660°		0..255	00..FF	0..100	
2) PAN-fine	High- Pos ... High- Pos +(16 Bit)		0..255	00..FF	0..100	
3) Tilt- coarse	0 .. 280°		0..255	00..FF	0..100	
4) Tilt-fine	High- Pos ... High- Pos + (16 Bit)		0..255	00..FF	0..100	
5) Color (fixed)	Colors adjustable via RGB		0..7	00..07	0..2,5	
	Color 01 - Red		8..15	08..0F	3..5,5	
	Color 02 - Amber		16..23	10..17	6..8,5	
	Color 03 – Yellow warm		24..31	18..1F	9..12,5	
	Color 04 - Yellow		32..39	20..27	13..15,5	
	Color 05 – Green		40..47	28..2F	16..18,5	
	Color 06 – Turquoise		48..55	30..37	19..21,5	
	Color 07 – Cyan		56..63	38..3F	22..24,5	
	Color 08 - Blue		64..71	40..47	25..27,5	
	Color 09 - Lavender		72..79	48..4F	28..30,5	
	Color 10 - Malve		80..87	50..57	31..34,5	
	Color 11 – Magenta		88..95	58..5F	35..37,5	
	Color 12 - Pink		96..103	60..67	38..40,5	
	White - CTO	Color temp. 3200K		104..111	68..6F	41..43,5
	White	Color temp. 5600K		112..119	70..77	44..46,5
	White – CTB	Color temp. 7200K		120..127	78..7F	47..49,5
Rainbow Effect Stop			128	80	50	
Rainbow Effect	slow – fast Color 01 -> Color 12		129..255	81..FF	51..100	
6) Red	Color mixing system - Red	0 - 100%	0..255	00..FF	0..100	
7) Green	Color mixing system - Green	0 - 100%	0..255	00..FF	0..100	
8) Blue	Color mixing system - Blue	0 - 100%	0..255	00..FF	0..100	
9) Shutter	Shutter closed		0..15	00..0F	0..5,5	
	Shutter pulse random	slow – fast	16..47	10..2F	6..18,5	
	Shutter ramp up	slow – fast	48..79	30..4F	19..31	

	Shutter ramp down	slow – fast	80..111	50..6F	32..43
	Shutter ramp up/down	slow – fast	112..143	70..8F	44..56
	Random strobe	slow – fast	144..159	90..9F	57..62
	Strobe effect pause	5s ...0,1s	160..199	A0..C7	63..77
	Strobe effect slow - fast	1 Hz .. 25 Hz	200..241	C8..F1	78..95
	Shutter open		242..249	F2..F9	95,5..96,5
	RESET 1	Only Head	250	FA	97
	RESET 2	All Funktionen	251	FB	98
	Shutter open		252..255	FC..FF	99..100
10) Dimmer	Dimmer	0% - 100%	0..255	0..FF	0..100
11) Zoom	Stepless adjustable Zoom	10°– 32°	0 .. 255	0..F F	0..100
12) Focus	Stepless adjustable Focus	infinity – near	0 .. 255	0..FF	0..100
13)Gobo1 (indexed)	Gobo 1 (open)		0...15	00..0F	0.5,9
	Gobo 2		16..31	10..1F	6..11,9
	Gobo 3		32..47	20.. 2F	12..17,9
	Gobo 4		48..63	30.. 3F	19.. 24,5
	Gobo 5		64..79	40..4F	25..30,5
	Gobo 6		80..95	50..5F	31..37,5
	Gobo		96..111	60..6F	38..43,5
	Gobo 8		112..126	70..82	44..48
	Gobo rotation STOP		127	7F	49
	Gobo rotation, slow-fast, CW		128..192	80..C0	50..76
Gobo rotation, fast-slow, CCW		193..255	C1..FF	77..100	
14) Gobo 1 Posi./Rot	Gobo position 0 ... 540°		0..127	00..7F	0..49
	Gobo rotation STOP		128..129	80..81	50
	Gobo rotation, slow-fast, CW		130..192	82..C0	51..75
	Gobo rotation, fast-slow, CCW		193..253	C1..FD	76..99
	Gobo rotation STOP		254..255	FD..FF	99..100
15)Gobo2 (indexed)	Gobo 1 (open, fast)		0...15	00..0F	0.5,9
	Gobo 2		16..31	10..1F	6..11,9
	Gobo 3		32..47	20.. 2F	12..17,9
	Gobo 4		48..63	30.. 3F	19.. 24,5
	Gobo 5		64..79	40..4F	25..30,5
	Gobo 6		80..95	50..5F	31..37,5
	Gobo 7		96..111	60..6F	38..43,5
	Gobo 8		112..126	70..82	44..48
	Gobo rotation STOP		127	7F	49
	Gobo rotation, slow-fast, CW		128..192	80..C0	50..76
Gobo rotation, fast-slow, CCW		193..255	C1..FF	77..100	
16) Gobo 2 Posi./Rot	Gobo position 0 ... 540°		0..127	00..7F	0..49
	Gobo rotation STOP		128..129	80..81	50
	Gobo rotation, slow-fast, CW		130..192	82..C0	51..75
	Gobo rotation, fast-slow, CCW		193..253	C1..FD	76..99
	Gobo rotation STOP		254..255	FD..FF	99..100

17) Effect wheel swing	Stepless swing of the "Motion Wheel"	0 - 100%	0..255	00..FF	0..100
18) Effect wheel Posi./Rot	Rotating stop		0..1	00..01	00..1
	Rotating slow - fast CW		1..128	01..80	1..50
	Rotating fast - slow CCW		129..254	81..FD	51..99
	Rotating stop		254..255	FD..FF	99..100
19) Prism	Prism swing out		0..5	00..05	0..2
	Prism position 0 ... 540°		6..127	06..7F	0..50
	Prism rotation stop		128..129	80..81	50,1
	Prism rotation, slow-fast, CW		130..192	82..C0	51..75
	Prism rotation, fast-slow, CCW		193..253	C1..FD	76..99
	Prism rotation stop		254..255	FD..FF	99.100
20) Iris	Iris open – closed		0..131	00..83	00..52

High Resolution (Extended)-Mode 31 DMX Channels

Kanal	Funktion	Zeiten und Werte	DMX	HEX	%
1) PAN- coarse	0 .. 660°		0..255	00..FF	0..100
2) PAN-fine	High- Pos ... High- Pos + (16 Bit)		0..255	00..FF	0..100
3) Tilt- coarse	0 .. 280°		0..255	00..FF	0..100
4) Tilt-fine	High- Pos ... High- Pos + (16 Bit)		0..255	00..FF	0..100
5) Color (fixed)	Colors adjustable via RGB		0..7	00..07	0..2,5
	Color 01 - Red		8..15	08..0F	3..5,5
	Color 02 - Amber		16..23	10..17	6..8,5
	Color 03 – Yellow warm		24..31	18..1F	9..12,5
	Color 04 - Yellow		32..39	20..27	13..15,5
	Color 05 – Green		40..47	28..2F	16..18,5
	Color 06 – Turquoise		48..55	30..37	19..21,5
	Color 07 – Cyan		56..63	38..3F	22..24,5
	Color 08 - Blue		64..71	40..47	25..27,5
	Color 09 - Lavender		72..79	48..4F	28..30,5
	Color 10 - Malve		80..87	50..57	31..34,5
	Color 11 – Magenta		88..95	58..5F	35..37,5
	Color 12 - Pink		96..103	60..67	38..40,5
	White - CTO	Color temp. 3200K		104..111	68..6F
White	Color temp. 5600K		112..119	70..77	44..46,5
White – CTB	Color temp. 7200K		120..127	78..7F	47..49,5
	Rainbow Effect Stop		128	80	50
	Rainbow Effect	slow – fast Color 01 ->Color 12	129..255	81..FF	51..100
6) Red- coarse	Color mixing system – Red	0 - 100%	0..255	00..FF	0..100
7) Red-fine	Color mixing system – Red-low		0..255	00..FF	0..100
8) Green- coarse	Color mixing system – Green	0 - 100%	0..255	00..FF	0..100
9) Green- fine	Color mixing system – Green-low		0..255	00..FF	0..100

10) Blue- coarse	Color mixing system – Blue	0 - 100%	0..255	00..FF	0..100
11) Blue-fine	Color mixing system – Blue-low		0..255	00..FF	0..100
12) Shutter	Shutter closed		0..15	00..0F	0..5,5
	Shutter pulse random	slow – fast	16..47	10..2F	6..18,5
	Shutter ramp up	slow – fast	48..79	30..4F	19..31
	Shutter ramp down	slow – fast	80..111	50..6F	32..43
	Shutter ramp up/down	slow – fast	112..143	70..8F	44..56
	Random strobe	slow – fast	144..159	90..9F	57..62
	Strobe effect pause	5s ...0,1s	160..199	A0..C7	63..77
	Strobe effect slow - fast	1 Hz .. 25 Hz	200..241	C8..F1	78..95
	Shutter open		242..255	F2..FF	96..100
13)Dimmer-coarse	Dimmer	0% - 100%	0..255	0..FF	0..100
14) Dimmer- fine	Dimmer low		0..255	0..FF	0..100
15) Color temp.	No color temperature correction		0..7	0..07	0..2,5
	Continuous color temperature correction between 7200k - 3200k	Applicable for ALL colors ⁵⁾	8..255	08..FF	3..100
12) Gobo Shake & Special	Gobo Shake for Gobowheel 1+2 off		0 .. 15	00..0F	0..5,5
	Gobo Shake Gobowheel 1	Speed 1 Size 1..8	16..23	10..17	6..9
		Speed 2 Size 1..8	24..31	18..1F	9,5..12
		Speed 3 Size 1..8	32..39	20..27	12,5..15
		Speed 4 Size 1..8	40..47	28..2F	15,5..18
		Speed 5 Size 1..8	48..55	30..37	18,5..21,5
		Speed 6 Size 1..8	56..63	38..3F	22..24,5
		Speed 7 Size 1..8	64..71	40..47	25..27,5
		Speed 8 Size 1..8	72..79	48..4F	28..30,5
	Gobo Shake Gobowheel 2	Speed / Size see Gobo Shake Gobowheel 1	80..143	50..90	31..56
	Gobo Shake Gobowheel 1+2	Speed / Size see Gobo Shake Gobowheel 2	144..207	91..CF	56,5..81
	Reset 1	Only Head	250..253	FA..FC	98..99
	Reset 2	All Funktionen	254..255	FD..FF	100
17) Zoom coarse	Stepless adjustable Zoom	10°– 32°	0 .. 255	0..F F	0..100
18) Zoom fine	Zoom low	(0% - 100%)	0..255	0..FF	0..100
19) Focus coarse	Stepless adjustable Focus	infinity – near	0 .. 255	0..FF	0..100
20) Focus fine	Focus low	(0% - 100%)	0..255	0..FF	0..100
21)Gobo1 (indexed)	Gobo 1 (open)		0...15	00..0F	0..5,9
	Gobo 2		16..31	10..1F	6..11,9
	Gobo 3		32..47	20.. 2F	12..17,9
	Gobo 4		48..63	30.. 3F	19.. 24,5
	Gobo 5		64..79	40..4F	25..30,5
	Gobo 6		80..95	50..5F	31..37,5
	Gobo 7		96..111	60..6F	38..43,5
	Gobo 8		112..126	70..82	44..48
	Gobo rotation STOP		127	7F	49
	Gobo rotation, slow-fast, CW		128..192	80..C0	50..76
	Gobo rotation, fast-slow, CCW		193..255	C1..FF	77..100

22) Gobo 1 Posi./Rot coarse	Gobo position 0 ... 540°		0..127	00..7F	0..49
	Gobo rotation STOP		128..129	80..81	50
	Gobo rotation, slow-fast, CW		130..192	82..C0	51..75
	Gobo rotation, fast-slow, CCW		193..253	C1..FD	76..99
	Gobo rotation STOP		254..255	FD..FF	99..100
23) Gobo 1 rot fine	Gobo 1 rot. low	(0% - 100%)	0..255	0..FF	0..100
24)Gobo2 (indexed)	Gobo 1 (open)		0...15	00..0F	0..5,9
	Gobo 2		16..31	10..1F	6..11,9
	Gobo 3		32..47	20.. 2F	12..17,9
	Gobo 4		48..63	30.. 3F	19.. 24,5
	Gobo 5		64..79	40..4F	25..30,5
	Gobo 6		80..95	50..5F	31..37,5
	Gobo 7		96..111	60..6F	38..43,5
	Gobo 8		112..126	70..82	44..48
	Gobo rotation STOP		127	7F	49
	Gobo rotation, slow-fast, CW		128..192	80..C0	50..76
Gobo rotation, fast-slow, CCW		193..255	C1..FF	77..100	
25) Gobo 2 Posi./Rot coarse	Gobo position 0 ... 540°		0..127	00..7F	0..49
	Gobo rotation STOP		128..129	80..81	50
	Gobo rotation, slow-fast, CW		130..192	82..C0	51..75
	Gobo rotation, fast-slow, CCW		193..253	C1..FD	76..99
	Gobo rotation STOP		254..255	FD..FF	99..100
26) Gobo 2 rot fine	Gobo 2 rot. Low	(0% - 100%)	0..255	0..FF	0..100
27) Effect wheel swing	Stepless swing of the "Motion Wheel"	0 - 100%	0..255	00..FF	0..100
28) Effect wheel Posi./Rot	Rotating stop		0..1	00..01	00..1
	Rotating slow - fast CW		1..128	01..80	1..50
	Rotating fast - slow CCW		129..254	81..FD	51..99
	Rotating stop		254..255	FD..FF	99..100
29) Prism	Prism swing out		0..5	00..05	0..2
	Prism position 0 ... 540°		6..127	06..7F	0..50
	Prism rotation stop		128..129	80..81	50,1
	Prism rotation, slow-fast, CW		130..192	82..C0	51..75
	Prism rotation, fast-slow, CCW		193..253	C1..FD	76..99
	Prism rotation stop		254..255	FD..FF	99.100
30) Iris coarse	Iris open – closed		0..131	00..83	00..52
31) Iris fine	Iris low		0..255	00..FF	00..100

Locking and unlocking the Control Panel

The Display will auto look automatically if the Touch Panel will not use for 10s. To unlock the Touch Panel you have to press one of the menu buttons for 2s..

¹⁾ **Colors**

The predefined colors can be used as start colors for the Rainbow effect. First select a desired start color, then activate the rainbow effect. All **Impression Spot One** will then begin from that color and execute the rainbow effect synchronously. Different **Impression Spot One** can have different start colors but will still execute the rainbow effect synchronously. If you choose a color different from the ones marked with ¹⁾ in the tables above the rainbow start-color will be red.

²⁾ **Rainbow-effect Stop**

will pause this function. After resuming the rainbow-effect will be continued with the current color.

³⁾ **The Rainbow-effect**

will run synchronously only if it is started from one of the predefined colors (see also ¹⁾ before).

⁴⁾ **Attention:**

Please note that shutter frequencies over 10 Hz are prohibited in some countries. Especially frequencies in the range of 5 - 12 Hz can possibly cause epileptic seizures → continuous blink irritation with a latency period of min. 70 ms. Please also refer to the relevant legislation of each country (For Germany for example: BGI 810-4 (Anhang 2) "Sicherheit bei Produktionen und Veranstaltungen - Scheinwerfer").

⁵⁾ **Color Temperature**

At anytime the **IMPRESSION Spot One** can be used the color correction for every RGB color.

3 Changing Gobos and the Effect wheel

3.1 Changing Gobos and the Effect wheel

The **Impression Spot One** is equipped both with Aluminum- and Glass gobos (outside diameter 27 mm, image size 20 mm). When using customized Gobos like company logos and writing the recommended image size is 18 mm. You can use either Aluminum (thickness = 0.5 mm) or glass gobos (thickness = 1.1 - 3.0 mm).

There are two gobo wheels with rotating gobos, with all gobos being interchangeable.

3.1.1 General remarks for changing gobos

All gobos or other optical effects have a dedicated mounting direction. To prevent undesired damages and to optimize the optical performance of your gobos, all gobos should be mounted with their reflecting side towards the LED light source.

- a) Aluminum gobos must be mounted with their unpainted side towards the LED light source, and the black painted side towards the front lens.
- b) Glass gobos must be mounted with their reflecting, or coated side, towards the LED light source.

To find out which is the coated side of a glass gobo, take a pencil and place the point gently on the gobo. If you have touched the coated side, there will be no distance between the pencil tip and its reflection in the gobo. If you have touched the uncoated side, there will be a small distance between the pencil tip and its reflection

Attention: Customized gobos like company logos, or those with writing also need to be placed in the holder with the correct orientation to ensure that the projected image reads correctly. Place the side of the gobo which reads correctly towards the LED light engine to ensure that it projects properly. Remember that the reflective side of the gobo should also be towards the LED light source, so please instruct the gobo manufacturer accordingly when having customized gobos made.





- c) Glass Gobos with a structured surface must be mounted with the structured surface towards the LED light source and the flat side towards the front lens.

3.1.2 *Changing rotating gobos*



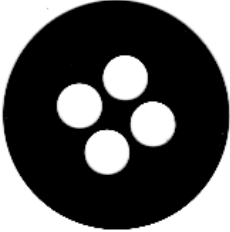

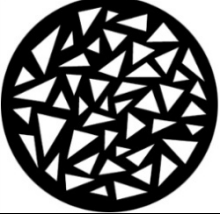
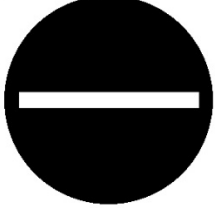
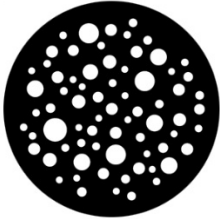

- 1) Open the fixture, using the quarter turn screws on the top cover.
- 2) Press the gobo holder at the outer part of the wheel carefully out of the hub. Pull it softly out of the central spring holder jig.
- 3) Now the gobo itself can be exchanged inside the gobo holder. Remove the concentric spring with a small screwdriver or gripping pliers. Change the gobo and put the spring in again.
- 4) Place the gobo holder back into the central spring holder jig in the middle of the gobo wheel and snap it into place. You can open the central spring holder with a bent screwdriver through a hole from the opposite side of the wheel.
- 5) Push the gobo holder in the dedicated hub.

Attention: There must be no gap between the gobo holder and the wheel afterwards. Check for a tight fit.

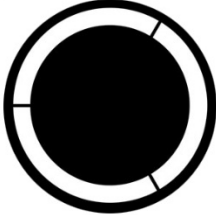
Gobowheel 1 (Rotation Gobos Ø 27 mm)

Position 1		4 Circles	
2		Vertical Bars	
3		Two Light Tunnels	
4		Triangles Random	
5		Dash Mini	
6		Dots Medium	
7		Starry Night Dense	

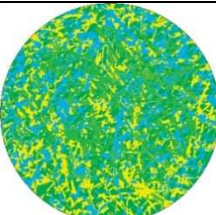
Gobowheel 2 (Rotation Gobos Ø 27 mm)

Position 1		Cone	
2		Leaves Foliage	
3		Teeth	
4		Shreds	
5		Angry Hurricane	
6		Shredded Earth	
7		Diamond Pattern	

3.1.3 Changing the effect wheel

- 1) Open the fixture.
- 2) Release the mechanical stop of the effect and move it up.

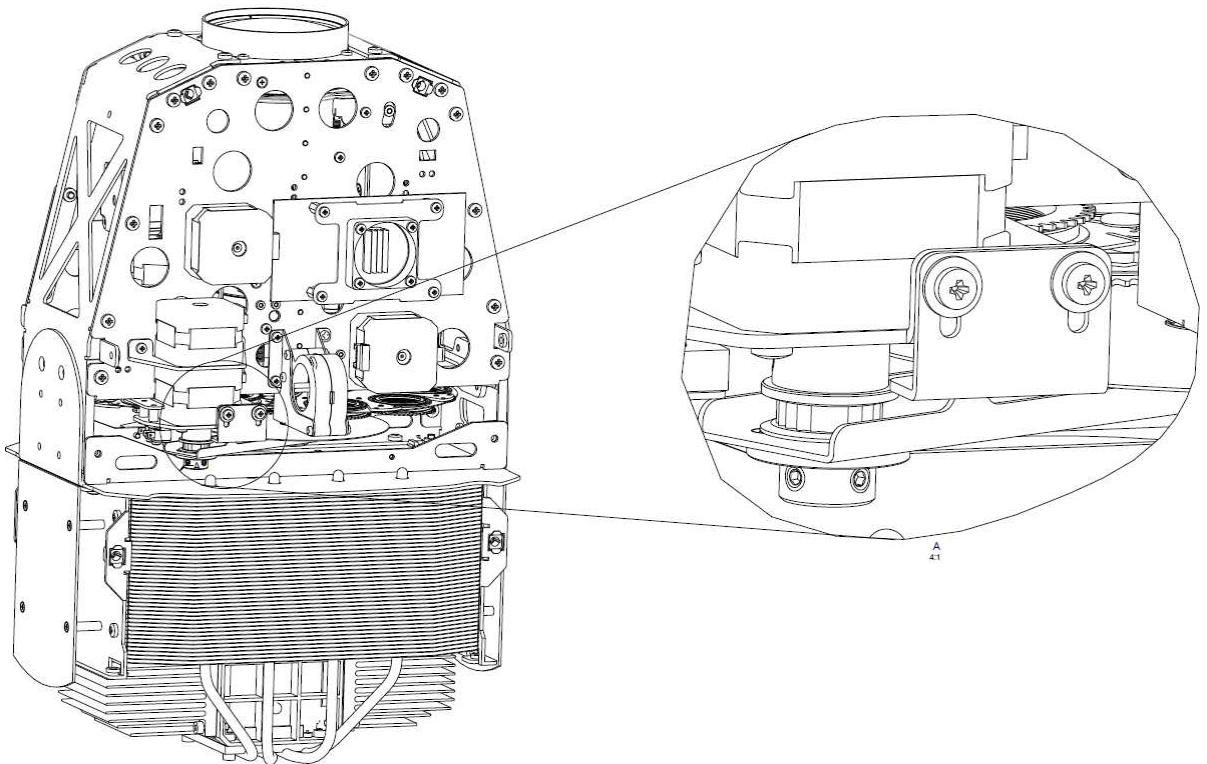

- 3) The Effect wheel can now be tilt out by hand.
- 4) The wheel itself is clipped on the wheel axis.
- 5) To remove it please use a slotted screwdriver and lift it out carefully from the wheel axis of the effect wheel.

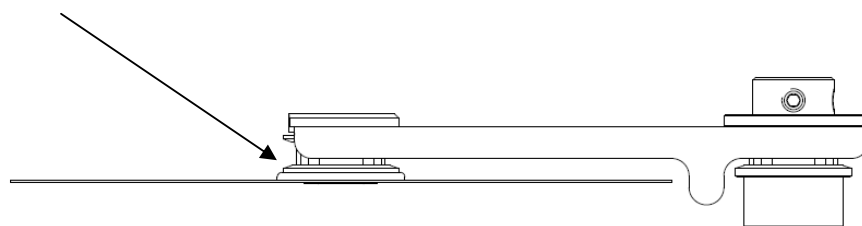

- 6) **Attention:** Don't pull the effect wheel out by grapping it with the hands at the border!
- 7) Change Effect wheel as desired and close the module in reverse order again.

Effect wheel insertion and spares:

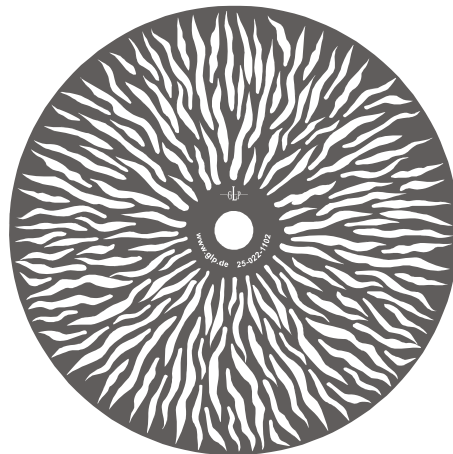

STANDARD

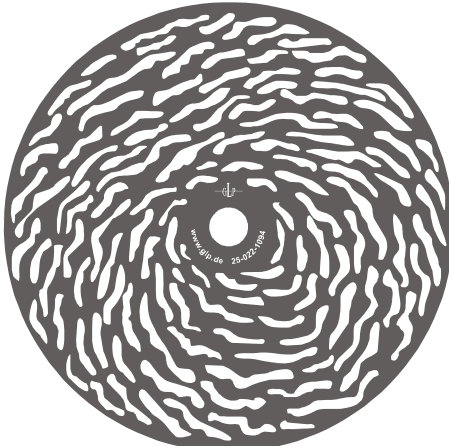

SPARE

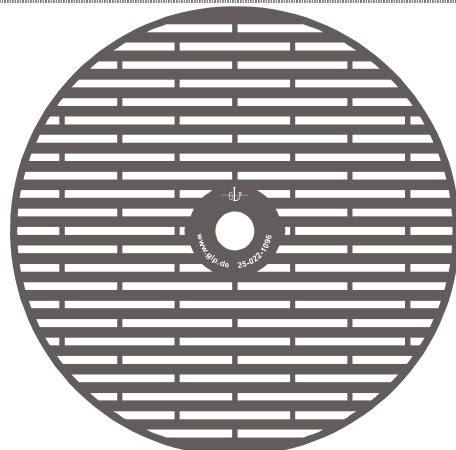

SPARE

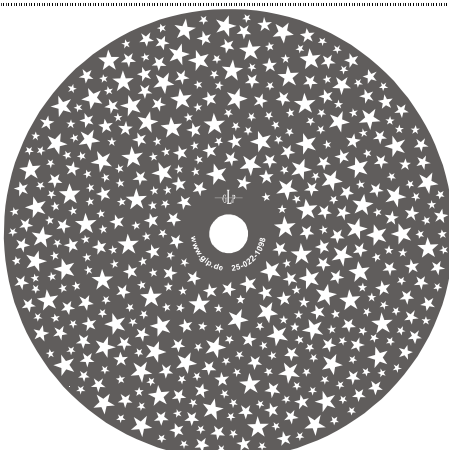



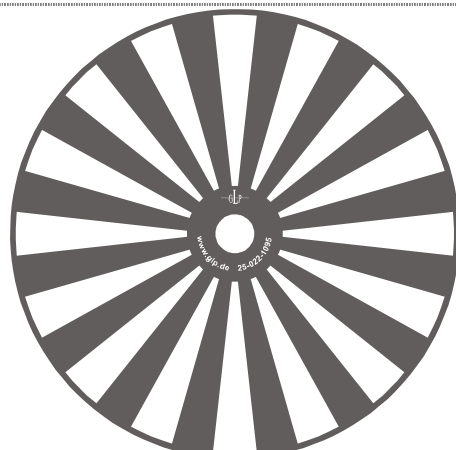

SPARE



SPARE

4 Colored Error Code

These state match to the following errors of the Impression Spot one:

Color	Meaning	Comment
	Red critical state	PCB could not find
	Yellow abnormal state	PCB send error back (hall sensor not found, encoder error, ...)
	Green normal state	Reset successful / finished error free
	White neutral	Reset activ, no state determined at the moment

5 Maintaining and Cleaning the Impression Spot one

The **Impression Spot one** is a low maintenance fixture. It is only necessary to clean the lenses, air inlets and outlets from time to time. For safe operation it is absolutely essential that the fixture is kept clean and that dust, dirt and smoke-fluid residues must not build up on, or within, the fixture. If they do, the fixture's light output will be significantly reduced, and damages to the fixture may occur. Regular cleaning will not only ensure the maximum light output, but will also allow the fixture to operate reliably throughout its entire life. **Under no circumstances should alcohol or solvents be used to clean the fixture or its lenses!**

5.1 Safety regulations

- **Disconnect the fixture from the mains power before commencing any maintenance work!**
- Wait minimum 15 minutes after removing the power to allow the fixture to cool down.

5.2 Maintenance Intervals (rule-of-thumb)

The maintenance schedule of any given fixture depends on the installation environment. Hence no specific guidelines can be given. The cleaning intervals given below are suggestions, based on practical experience. We suggest that you start with these and develop your own maintenance schedule as you see the fixtures performance in your specific environment.

Maintenance Task	Interval	How
Outside optic	weekly	soft cloth and glass cleaning fluid
Gobos	yearly	vacuum cleaner, airbrush, etc.
Glass gobos	yearly	soft cloth and glass cleaning fluid
Prism	yearly	soft cloth and glass cleaning fluid
Iris	yearly	vacuum cleaner, airbrush, etc.
Inside lens	yearly	soft cloth <u>no</u> glass cleaning fluid
Fan and air channel	monthly	vacuum cleaner, airbrush, etc.
Moveable parts	yearly	suitable fatty oil

Attention:

- Never let optical parts come into contact with oil or fat.
- Before running the fixture wait until all parts are touch dry.
- Never touch lenses with bare fingers.

6 Technical Specifications

Power supply	
Power consumption	700 VA (Watt)
Power input	Auto sensing 100-240 V AC, 50-60 Hz
Fuse protection	Micro-fuse 6.3x32 mm, T8A
Operational Parameters	
Max. ambient temp.	45°C / 113°F (integrated overheating switch)
Mounting position	Any (See Mounting chapter)
Lighting System - Additive Color mixing	
LED type	400W RGB LED Chipset
Lifetime	20.000 h
Shutter / Dimmer (8/16 Bit)	
Strobe Effect with variable speed between 1 & 50 flashes per second, Random strobe, Pulse effects	
Continuous dimmer 0 - 100%	
Prism (8 Bit)	
Rotating 3-facet prism, bi-directional and variable in speed	
Focus (8/16 Bit)	
Motor driven focus from near (1 mtr.) to infinity	
Iris (8Bit)	
High speed iris 100% - 4% (0,2 Sec. opening time)	
Effect wheel (8/16 Bit)	
Rotating and indexable effect wheel, bi-directional and variable in speed. Interchangeable for different patterns	
Zoom (8/16 Bit)	
Zoom range 10° - 32°	
Gobos (8/16 Bit)	
Gobo wheel 1 & 2: each 7 interchangeable rotating and indexed gobos plus open, variable speed and bi-directional	
Gobo dimensions: Glass gobo thickness: 1.1 - 3.0mm Aluminium gobo thickness: 0.5mm / Outside diameter: 27 mm / Image size: max. 20 mm. For customized gobos like company logos and text the recommended image size is 18 mm.	
DMX Control	
Standard USITT DMX-512, 3/5 pole XLR; [+]= Pin 3 [-]= Pin 2 [Ground]= Pin 1.	
Pan / Tilt (8/16 Bit) - 3 phase stepper motor	
Pan- movement	660° (Position Feedback)
Tilt- movement	280° (Position Feedback)
Weights and Measures	
Width of the base	472 mm / 18.6 inch.
Length of the base	230mm / 9 inch.
Height (head vertical)	618mm / 24.3 inch.
Fixture weight	23 kg / 50.7 lbs.
Floor stand weight	2 kg / 4.4 lbs.

7 Index

<hr/>	
A	
Anleitung Version	1
<hr/>	
B	
BGV C1.....	6
<hr/>	
C	
Changing Effect wheel.....	26
Circumference	29
Cleaning.....	28
<hr/>	
D	
Description of Device.....	4
DIN VDE 0711-217	6
DMX	9
<hr/>	
E	
e-mail.....	1
Enter-key	9
Eyelets	7
<hr/>	
G	
Geräteübersicht	4
Gobowechsel	22
<hr/>	
H	
<i>Half-couplers (clamps)</i>	8
<hr/>	
I	
Internet.....	1
<hr/>	
L	
LED Class 2M	5
<hr/>	
M	
Maintenance	28
<hr/>	
Menu Field	9
Menüfeld	9
Micro-fuse	9
Mode-key	9
Mounting	6
Mounting in hanging Position.....	7
Mounting on the Floor	7
<hr/>	
O	
Optical parts	29
<hr/>	
P	
Pan- Movement.....	30
Power Supply	9
Powercon (Netzanschluss	4
<hr/>	
S	
Safety distance	6
Safety Instructions	5
Secure the Device	8
Software Version.....	1
<hr/>	
T	
Tilt- Movement	30
<hr/>	
U	
Up/Down-keys	9
<hr/>	
V	
VBG 70	6
<hr/>	
W	
Warranty claims	6
Wartung	22
Weights and Measures	30

