

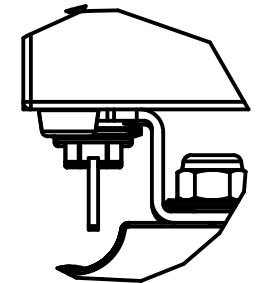

SIEHE DETAIL A

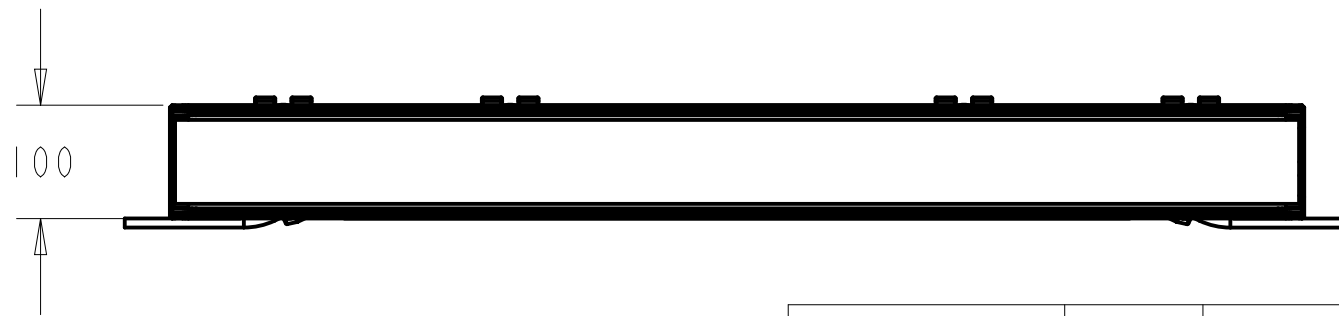

DETAIL A  
MASSTAB 0.500

Tilt movement range: 210°

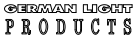
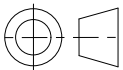
UNLESS OTHERWISE SPECIFIED	DRW:	PART NO.: 1		 GERMAN LIGHT PRODUCTS GMBH IM STOECKMAEDLE 13 76307 KARLSBAD - GERMANY PHONE: +49 (0)7248/92719-0 WWW.GLP.DE	
	CHK:	DRAWING NO.: 1			
DIMENSIONAL TOLERANCES: <6 = ± 0.05 6-30 = ± 0.1 30-120 = ± 0.15 >120 = ± 0.2 ANGLES = ± 0.5°	APR:	DATE: 27-Nov-14	REV.: 1		
	PROPRIETARY NOTICE:	DESCRIPTION: Impression X4 Bar 20			
ALL INFORMATION HEREIN IS THE SOLE AND EXCLUSIVE PROPERTY OF GLP, AND MAY NOT BE USED, DISCLOSED OR REPRODUCED IN ANY MANNER WITHOUT THE ADVANCE WRITTEN CONSENT OF GLP.	SIZE A4	MATERIAL: 0	FINISH:		
	THIRD ANGLE PROJ. 	ALL DIMENSIONS ARE IN MILLIMETERS UNLESS NOTED OTHERWISE. REMOVE ALL BURRS AND SHARP EDGES.		FILENAME: X4BAR20_DIMENSIONS	
		DO NOT SCALE	SCALE 0.150	SHEET 1 OF 2	

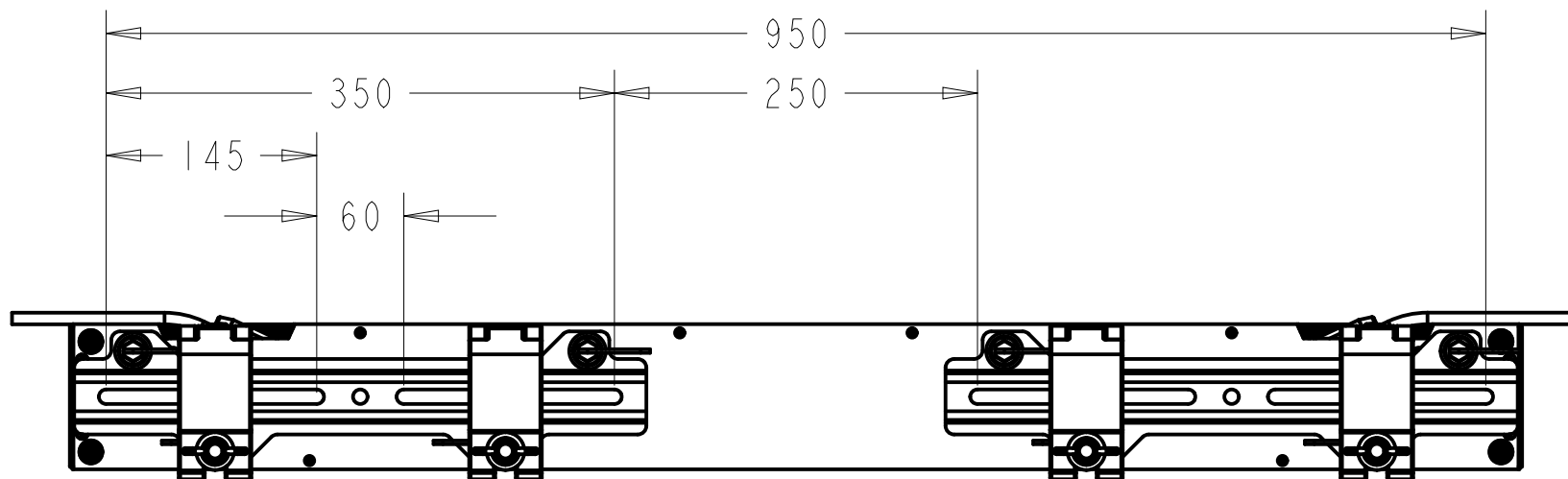

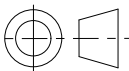
UNLESS OTHERWISE SPECIFIED  DIMENSIONAL TOLERANCES: <6 = ± 0.05 6-30 = ± 0.1 30-120 = ± 0.15 >120 = ± 0.2 ANGLES = ± 0.5°  PROPRIETARY NOTICE:  ALL INFORMATION HEREIN IS THE SOLE AND EXCLUSIVE PROPERTY OF GLP, AND MAY NOT BE USED, DISCLOSED OR REPRODUCED IN ANY MANNER WITHOUT THE ADVANCE WRITTEN CONSENT OF GLP.	DRW:	PART NO.: 0		 GERMAN LIGHT PRODUCTS GMBH IM STOECKMAEDLE 13 76307 KARLSBAD - GERMANY  PHONE: +49 (0)7248/92719-0 WWW.GLP-DE
	CHK:	DRAWING NO.: 2		
	APR:	DATE: 27-Nov-14	REV.: 0	
	SIZE A4	DESCRIPTION: Impression X4 Bar 20		
	THIRD ANGLE PROJ.	MATERIAL: 0	FINISH:	
		ALL DIMENSIONS ARE IN MILLIMETERS UNLESS NOTED OTHERWISE. REMOVE ALL BURRS AND SHARP EDGES.		FILENAME: X4BAR20_DIMENSIONS
	DO NOT SCALE	SCALE 0.200		SHEET 2 OF 2